

# PROFILE

L 1500MM  
W 700MM

PROFILE	5MM	CARRONITE
L-PANEL 1500x700x515	✓	✓
FRONT PANEL 1500x515	-	✓
END PANEL 700x515	✓	✓
SCREEN CFS-1 (H=1400MM)	✓	✓
SCREEN CFS-2 (H=1500MM)	✓	✓

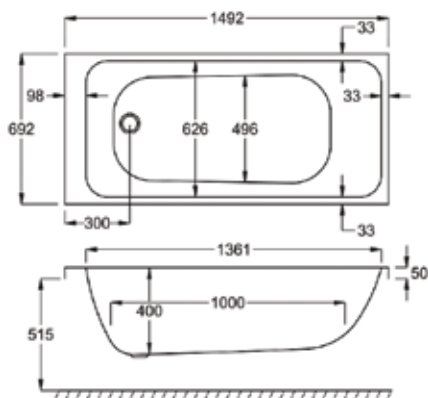

Carronite



Panel

## WATER CAPACITY

190 LTR

This measurement is taken to the overflow

## WHIRLPOOL COMPATIBLE

N/A

## KIT REFERENCES

STANDARD - AK-01

CARRONITE - AK-01-C